



GSM/GPRS/3G/4G Sensor To Cloud IoT Series



Transmits Sensor/Meter signal to Cloud Platform;
Ultra-Low Power consumption,small size,easy operation;
PCBA,Metalical Enclosure, Waterproof Enclosure;
Supports DIN/Relay Output/AIN/DS18B20/AM2301/RS485;
Supports GSM/GPRS/3G/4G/NB-IoT/Lora;
Supports Cloud Platform,Modbus TCP,MQTT, SMS, Dial Alert.

Sensor to Cloud IoT Series

KING PIGEON



Sensor To Cloud

User Manual

Version: 2.0

Model: IOT1xx

Date: 2019-08-15

All rights reserved by

King Pigeon Hi-Tech. Co., Ltd.

WWW.IOT-SOLUTION.COM



[Preface]

Thank you for using the Sensor To Cloud IoT Series device of King Pigeon Hi-Tech. Co., Ltd. Reading this product description allows you to quickly grasp the function and use of this product.

[Copyright statement]

The ownership of this specification is owned by King Pigeon Hi-Tech. Co., Ltd. Without the written permission of the company, no unit or individual has the right to reproduce, disseminate and copy any part of the manual in any form, otherwise the offender will be at his own risk.

[Disclaimer]

The company cannot provide free upgrade services if the Device cannot continue to be used because of the network upgrade of the operator. The company will not bear the consequences if the Device is unable to work properly due to the interruption of the network services of the operators.

This product is mainly based on GSM/3G/4G network, please use it according to the parameters and technical specifications provided in the specification, and please pay attention to the radio products, especially GSM/3G/4G. The company does not bear property or personal injury caused by improper use of the product.

[Document revision record]

Date	Version	Revised instructions
2019-02-22	V1.0	The first version
2019-08-15	V1.1	Update model
2019-12-18	V2.0	Upgrade PCB, add DIN pulse counter function

[Device selection table]

Order Model	I/O type	Communication (Optional)	Communication Protocol (Optional)
IOT100	RS485 Transparent Transmission	1: GSM/GPRS 2: 3G 3: 4G LTE	1: Modbus RTU Over TCP 2: MQTT 3.Transparent transmission
IOT101	DIN: Digital Input or Pulse Counter		
IOT102	DO: Digital Output-Open Collector		
IOT103	AIN: 4~20mA / 0~5V Analog Input		
IOT104	AM2301 Temperature & Humidity Sensor Input		
IOT105	DS18B20 Temperature Sensor Input		



Table of contents

1. Brief Introduction.....	5
2. Safety Note.....	5
3. Packing List.....	5
4. Functional Characteristics.....	6
5. Technical parameters.....	7
6. Device Description.....	8
6.1. Indicator Light Instructions.....	8
6.2. Wiring instructions.....	9
6.3. SIM Card Installation.....	13
6.4. DIN Dry/Wet Contact Selection.....	14
7. Factory Data Reset.....	14
8. Configuration Software.....	15
8.1. Preparatory Work.....	15
8.2. Configuration Software Functions Overview.....	16
8.3. Basic Settings.....	16
8.4. Number Settings.....	18
8.5. Network Settings.....	19
8.6. I/O Settings.....	21
The I/O parameter page displays different parameter settings pages according to the device model.	21
8.6.1. DO - Digital Output (Open Collector) Settings.....	21
8.6.2. DIN - Digital Input Settings.....	22
8.6.3. AIN - Analog Input Settings.....	23
8.6.4. DS18B20 Temperature Settings.....	24
8.6.5. AM2301 Temperature & Humidity Settings.....	25
8.6.6. RS485 Settings.....	27
8.7. Timer Settings.....	28
8.8. Debug.....	29
9. SMS Instructions.....	29
9.1. Set new password.....	30
9.2. Set the SIM card number.....	30
9.3. Set time of device.....	30
9.4. Set the user Tel number.....	30
9.5. Query device status.....	31
9.6. Set working mode.....	31
9.7. Set Device ID.....	31
9.8. Set network parameter of SIM card.....	31
9.9. Set server parameters.....	32
9.10. Enable/Disable network.....	32
9.11. Set Login Message.....	32
9.12. Set Heartbeat Message (only for Modbus protocol).....	32
9.13. Set the Heartbeat Interval.....	33
9.14. Set DO output parameters (only for DO output).....	33



9.15. Set threshold high and low (only for AIN, DS18B20, AM2301 input).....	33
9.16. Set the range of AIN (only for AIN input).....	34
9.17. Calibrate the accuracy of AIN (only for AIN input).....	34
9.18. Delete cache data.....	34
9.19. Reboot Device.....	35
9.20. Restore factory settings.....	35
9.21. Set device language.....	35
9.22. Clear DIN Pulse Counter(Only for DIN).....	35
10. Transmission protocol.....	35
10.1. Modbus RTU protocol.....	35
10.1.1. Modbus address and example of DO types.....	35
10.1.2. Modbus address and example of DIN types.....	36
10.1.3. Modbus address and example of AIN types.....	37
10.1.4. Modbus address and example of DS18B20 types.....	37
10.1.5. Modbus address and example of AM2301 types.....	38
10.2. MQTT Protocol.....	39
10.2.1. MQTT data format published by DO types.....	39
10.2.2. MQTT data format Published by DIN Type.....	39
10.2.3. MQTT data format published by AIN types.....	40
10.2.4. MQTT data format published by DS18B20 types.....	41
10.2.5. MQTT data format published by AM2301 types.....	41
11. Warranty.....	41
12. Appendix A - SMS Instructions Table.....	42

1. Brief Introduction

The Sensor To Cloud IoT Series include DO - Digital Output (Open Collector), DIN - Digital Input, AIN - 4~20mA Analog Input, AIN - 0~5V Analog Input, DS18B20 Temperature Sensor Input, AM2301 Temperature & Humidity Sensor Input, RS485 Transparent Transmission etc. I/O types of different functions, optional GSM, GPRS, 3G, 4G, NB-IoT, etc. communication methods, support for Modbus RTU Over TCP and MQTT communication protocols or data transparent transmission, covering most of the applications to meet the different needs of users.

This product is compact and exquisite, powerful, and can choose the regular online working mode or ultra low power working mode according to the need. It can choose the waterproof plastic shell for industrial metal shell or outdoor use, acting as a complete finished product connection sensor monitors data collection, remote control and abnormal warning notifications through SMS, phone, network, wechat, web end and cloud platform. It can also be used as a PCBA module embedded in a third-party motherboard for secondary development, to facilitate the traditional sensors, instruments and other rapid access to objects such as networking.

2. Safety Note



Safety tips

Please do not use this product in places where it is forbidden to use mobile phones!



Wireless interference

This product uses GSM/3G/4G wireless network, please pay attention to wireless interference!

3. Packing List

IOT Module x1, GSM/3G/4G antenna x1, USB Cable x1, power adapter (DC 12V/1A) x1, Manual*1

Note: SIM cards are not included in the list.

Optional Accessory:

DS18B20 temperature detector, length: 1m, 5m, 10m, 20m

AM2301, AM2401 temperature and humidity detector, length: 1m, 5m, 20m

DIN 35mm rail fixed support:



4. Functional Characteristics

- It can be used as a complete product or as a secondary development of the PCBA module.
- Two modes of work are optional:
 - Normal mode: data transmission in real time, so that users can understand the situation on the spot in a timely manner;
 - Low power mode: ultra low power source design (less than 230uA), suitable for the periodic collection of recorded data sites;
- A variety of communication options are available: GSM, GPRS, 3G, 4G, NB-IoT, etc.
- Diversified functions: switch control, digital input monitoring, analog input monitoring, temperature and humidity monitoring, RS485 serial communication, etc.
- DIN supports pulse count, compatibles dry contact and wet contact, supports max 1KHz pulse counter.
- Support for setting parameters through SMS, computer configuration software, cloud platform(change the configuration and viewing real-time data);
- Supports 10 user numbers, each of which can be set up separately to receive specific alarm messages and alarm calls;
- Support 10 timer task: Inbuilt inter-lock logic programmer and powerful timer program function
- Supports 2 different server centers that can set IP addresses or domain names;
- Support for Modbus RTU Over TCP protocol and MQTT protocol or data transparent transmission;
- Resend mechanism To ensure that each data is effectively uploaded to the server;
- 32M-bit storage to save historical data.
- Wide working voltage design, support 7~24 VDC power supply, with anti-reverse connection protection;
- Built-in clock chips and super capacitors to ensure long-term timing after power outages;
- Use the nano SIM card to support pin code verification and ensure the security of the card;
- The optional metal shell or waterproof shell, can be installed and used in the house and outdoors.

5. Technical parameters

Item	Parameter range
Working voltage	Standard power supply 12V DC, support 7~24V DC
Power consumption	< 230uA in low power mode; 10mA~30mA in normal mode; Maximum 230-360mA (when making a phone call, it is related to the strength of the signal; and the weaker the signal, the bigger the consumption)
Means of communication	Optional < GSM , GPRS, 3G, 4G, NB-IoT >
Communication protocol	Modbus RTU over TCP protocol, MQTT protocol, Data transparent transfer
SIM card	Nano SIM card
External antenna	SMA Antenna interface, 50 Ohm
USB	Micro USB interface
DO - digital output	OC type - open collector output, maximum load 1.5A/25V DC
DIN - digital input	Dry and wet contact compatible; default is wet contact(Freely switchable to dry contact). Dry contact :Open is logic 0,close is logic 1, Wet contact:0~3V is close, 5~30V is open
DIN Pulse counter	Debounce mode:max pulse frequency is 50Hz; No debounce mode: max pulse frequency is 1KHz
AIN - analog input	4~20mA or 0~5V
AM2301 temperature and humidity input	AM23001: temperature measuring range -40 to 80°C, precision ±0.5°C, humidity measuring range 0~99.9%RH, precision ±3%RH
DS18B20 temperature input	DS18B20: temperature measurement range -55 to 125°C, precision ±0.5°C
RS485 serial communication	A single package transmitted through the RS485 serial port is up to 250 bytes.
Cache capacity	32M-bit / 4M-Byte (4,194,304 Bytes)
Working temperature range	-10 to 60°C
Working humidity range	Maximum relative humidity 95% (condensation free)
Protection class	IP66
Water Proof Shell Size	101mm * 69mm * 39mm

6. Device Description

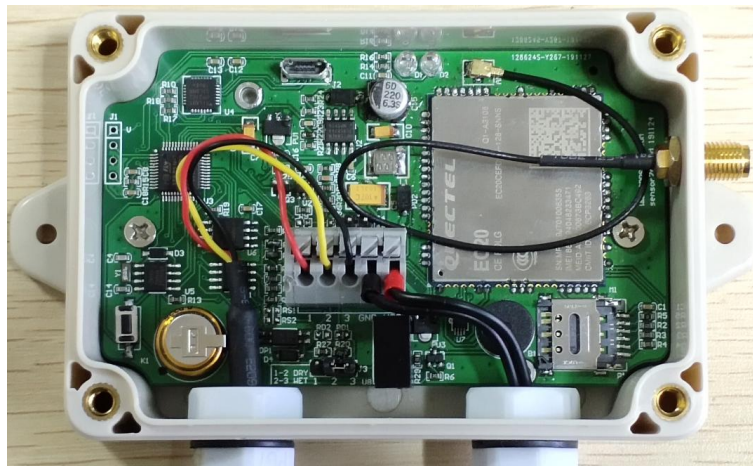
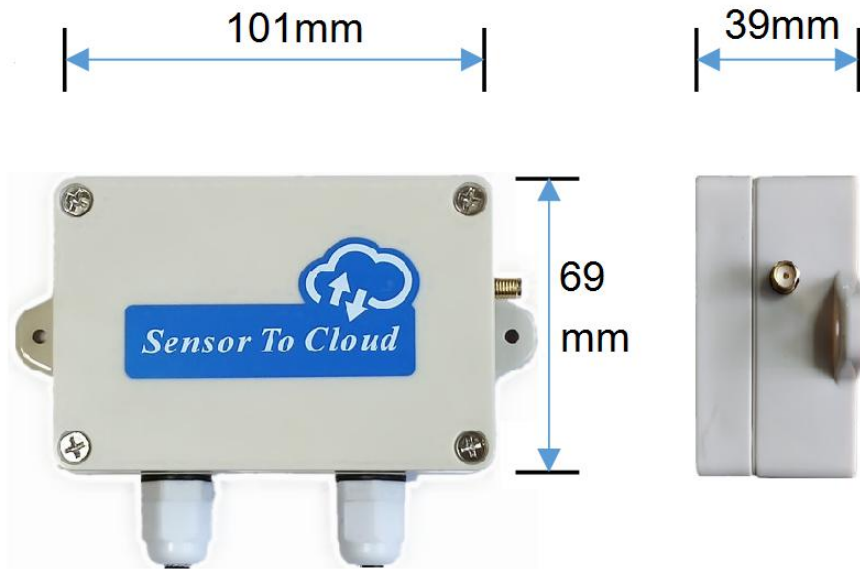

6.1. Indicator Light Instructions

Indicator instructions	
Signal indicator light(Left)	Flicker when just turned on, signal registered successfully will always on, registration failure or no signal continues to blink.
I/O indicator light(Right)	Blink when DIN, AIN, DS18B20 temperature input, AM2301 temperature & humidity input was triggered (Buzzer follow) ,extinguished when recovery; Light will on when DO closed , Off when DO open; Blink when RS485 is transmitting data.

6.2. Wiring instructions

Terminal identification	IOT100 RS485	IOT101 DIN	IOT102 DO	IOT103 AIN	IOT104 AM2301	IOT105 DS18B20
1	RS485-B (DATA-)	DIN negative	Null	Null	VCC Power	VCC Power
2	RS485-A (DATA+)	DIN positive	DO positive	AIN positive	DATA line	DATA line
3	RS485-GND (Nullable)	Null	DO negative	AIN negative	GND line	GND line
GND	DC7~24V negative					
VCC	DC7~24V positive					

IOT100 RS485 WIRING

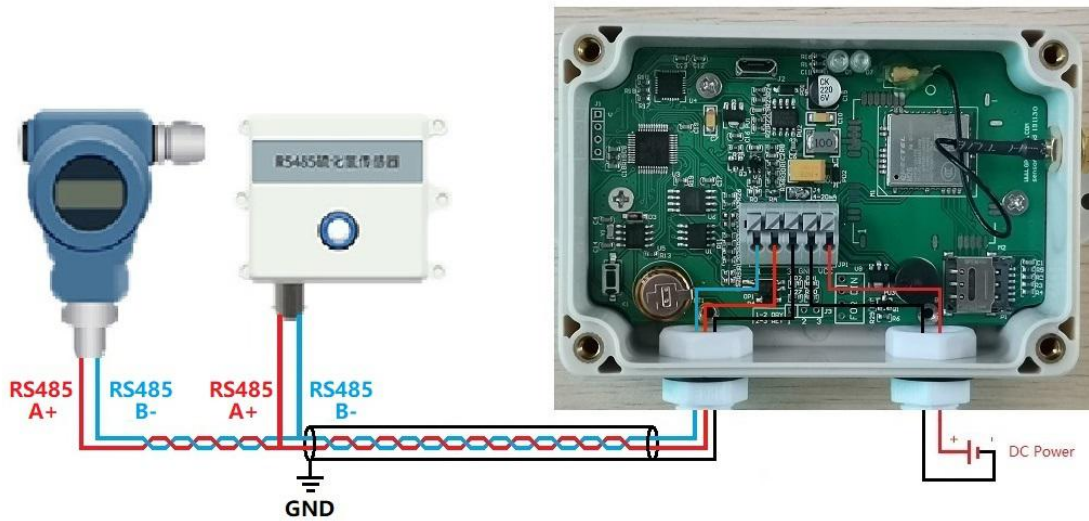

IOT101(DI)

I/O Diagram

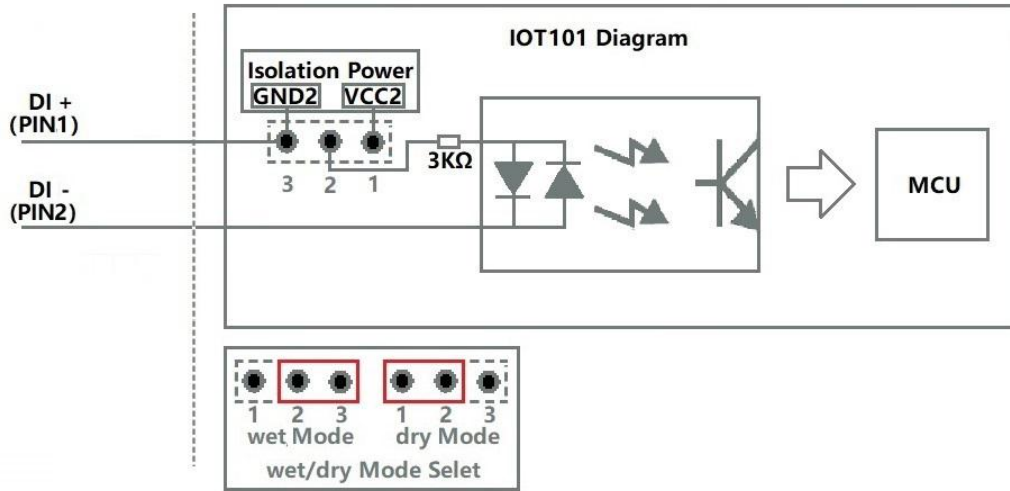

IOT101 Dry Contact

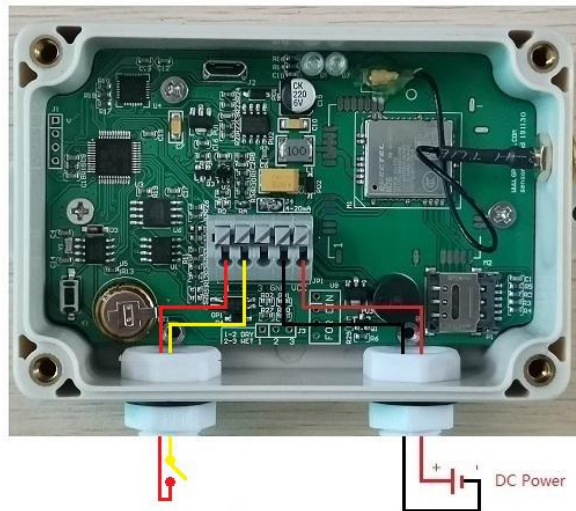

IOT101 Wet Contact NPN

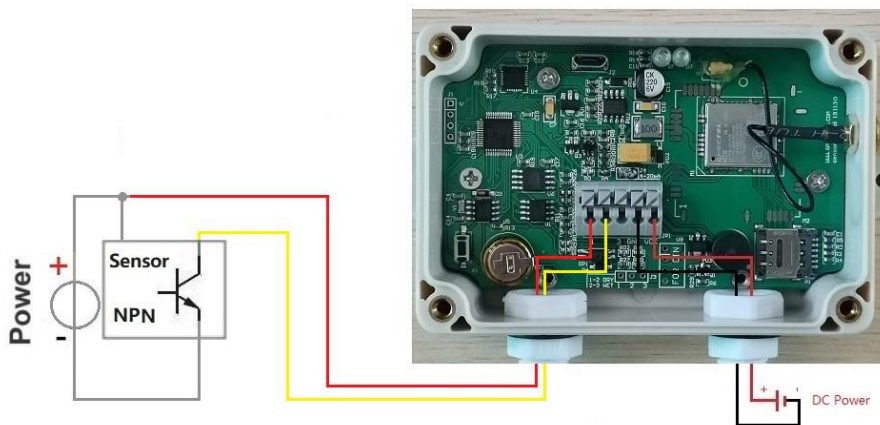

IOT101 Wet Contact PNP

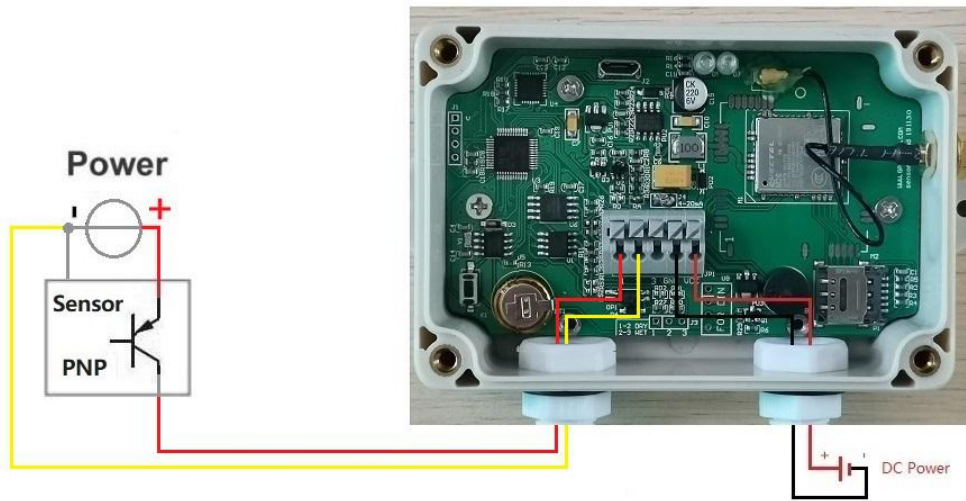

IOT102 (DO) I/O Diagram

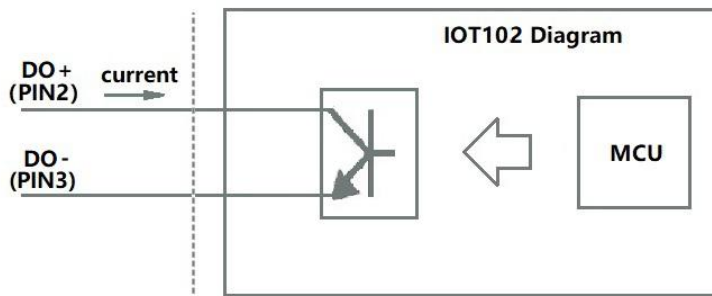

DO Sink

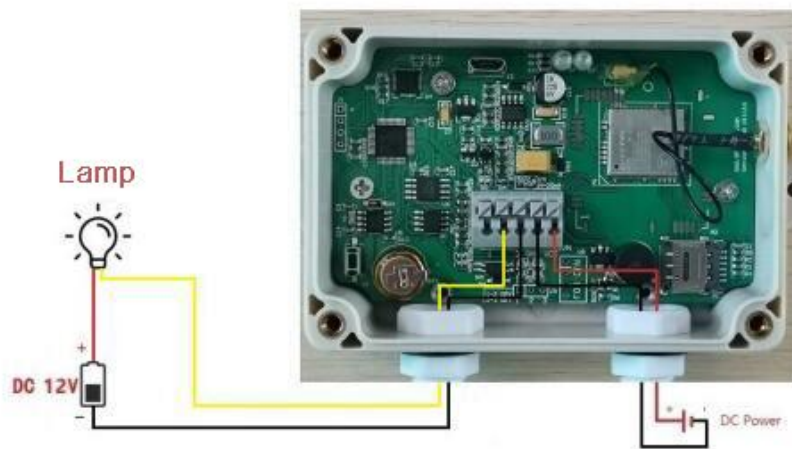

IOT103 (Analog Input (0-5V or 4-20mA))

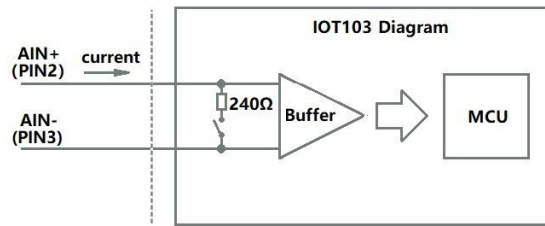

2 Wire Sensor

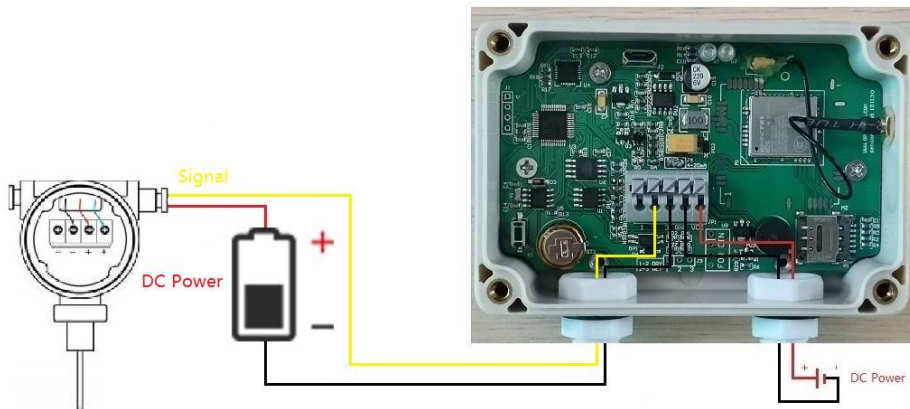

3 Wire Sensor

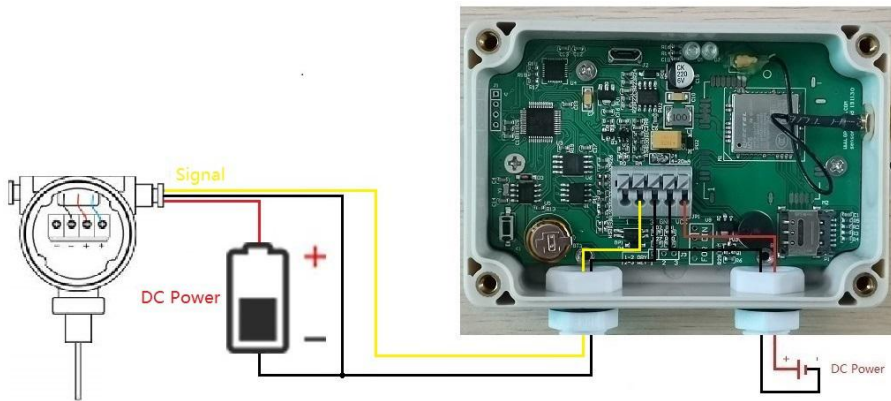

4 Wire Sensor

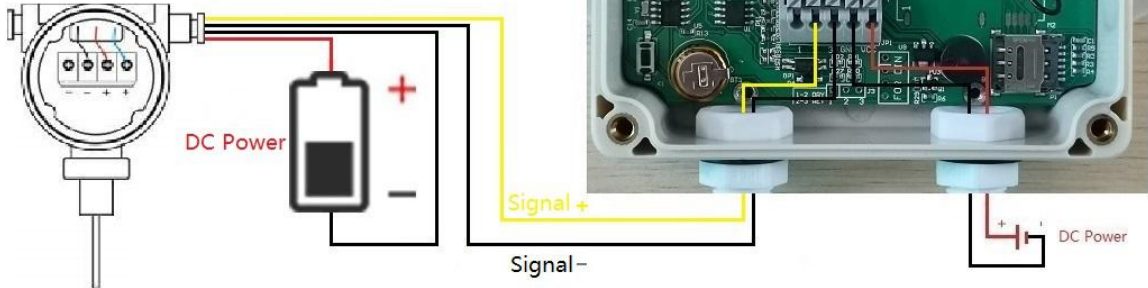

IOT104(AM2301)

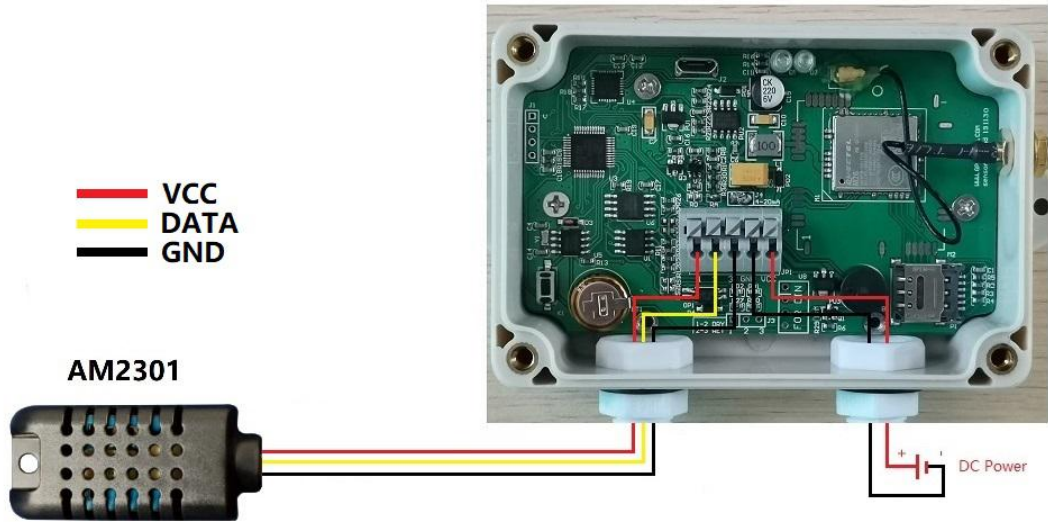

IOT105 (DS18B20)

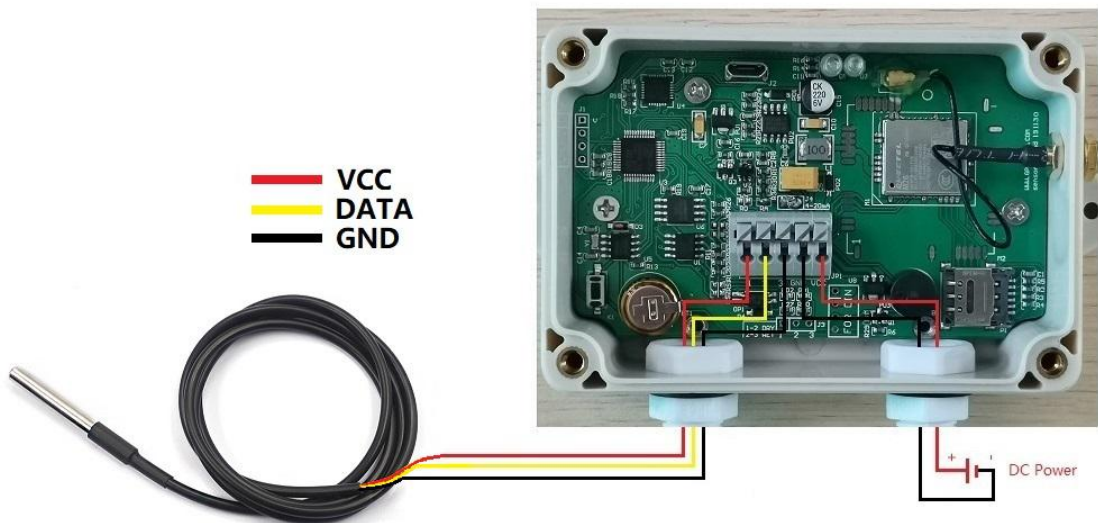

6.3. SIM Card Installation

Below the indicator light, you can see the flip-type Nano-SIM card holder by opening the case. The SIM card is inserted with the chip facing down and the notch facing in. The side of the metal case has an opening to insert the card directly. When you open the card, you can insert the card and push the cover to the right to open it. Place the SIM card as shown in the figure, and then push the cover to the left to fasten.

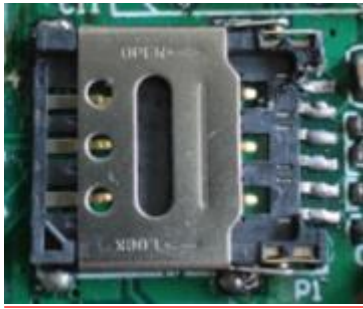

6.4. DIN Dry/Wet Contact Selection

The DIN supports dry contact and wet contact input, default is wet contact. To switch to dry contact input, you can open the case, Under the terminal, connect the jumper cap on J3 to pins 1 and 2, as shown below :

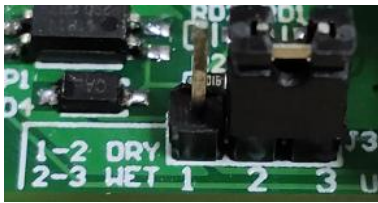

Wet contact: Connect J3 cap to 2,3 pin

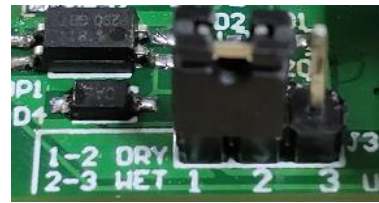

Dry contact: Connect J3 cap to 1,2 pin

7. Factory Data Reset

Some methods to restore factory settings:

- (1) Connect the computer configuration software and reset it by the "Reset" button of the configuration software;
- (2) Remote reset by sending the message instruction "password+RESET", if success to reset , you will get the returning message.
- (3) Open the shell, you can see the only small button K1 (Bottom left corner), long press the button 3 seconds during the device is powered on. If I/O indicator light is on for 3 seconds, that indicates a successful reset (the I/O indicator light of the DO output model flash only one second to show successful).

8. Configuration Software

This product provides special configuration software for configuration of parameters. Uses USB line to connect the device to the PC, The operation of parameter setting, parameter export, parameter import, device parameter query can be carried out quickly.

8.1. Preparatory Work

- (1) Download driver from http://rtu-m2m.com/Download/Software/CP210x_Windows_7_8_10_Drivers.zip and install it on the computer, or finish the installation driver through third-party driver software;
- (2) Download the Sensor To Cloud configuration software , and then unzip and run it;
- (3) Insert the SIM card into the card seat of the device, and ensure that the connection is reliable, and install the antenna at the same time;
- (4) To connect the power supply to the input port of the device, pay attention to the positive and negative pole not to be connected reverse;
- (5) Use the USB line to connect the device to the computer;
- (6) Turn on the device management of the computer, and if the connection is normal and the driver is installed properly, the sign below appears.

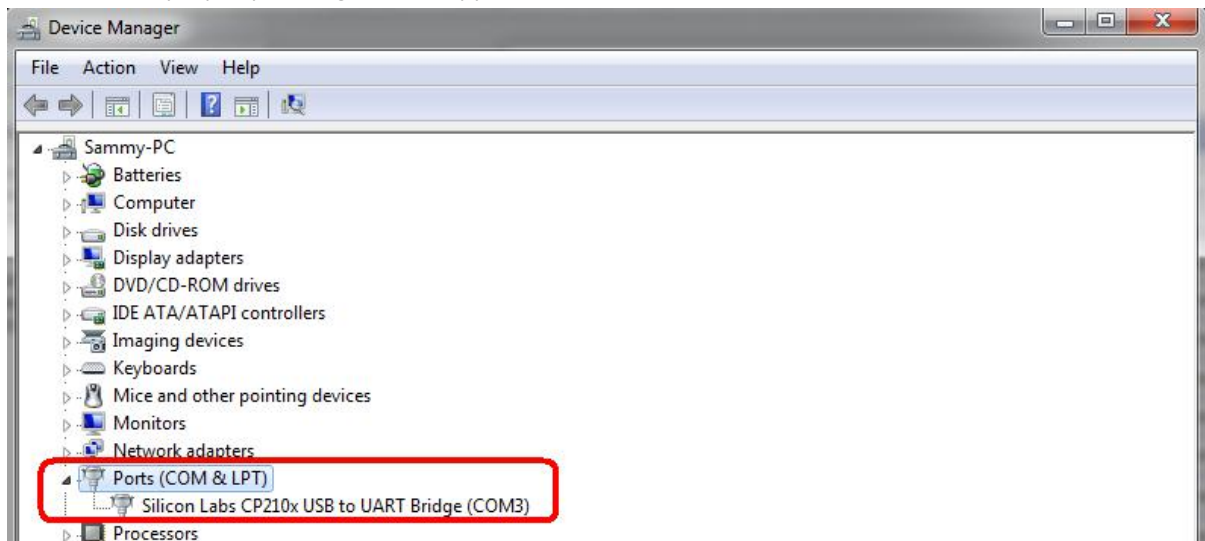

- (7) Run configuration software, select the port number seen in the device management, enter the device password (the default password is 1234), click on the connection.



[Note] If the connection is not successful, please check whether the connection is secure and whether the serial number and password are correct.

8.2. Configuration Software Functions Overview



- **[Read]** Read the current configuration of the reading device before editing the parameters.
- **[Save]** Save settings write the edited parameters to the device, and the edited parameters will only take effect if they are saved.
- **[Load]** To import the previously saved configuration file parameters into the device, you can quickly configure the device.
- **[Export]** Save the edited parameter configuration to the computer configuration file for the next configuration.
- **[Reset]** All parameters of the device will be restored to the factory default value after the factory is clicked.
- **[Reboot]** Restart the device immediately after clicking.

8.3. Basic Settings

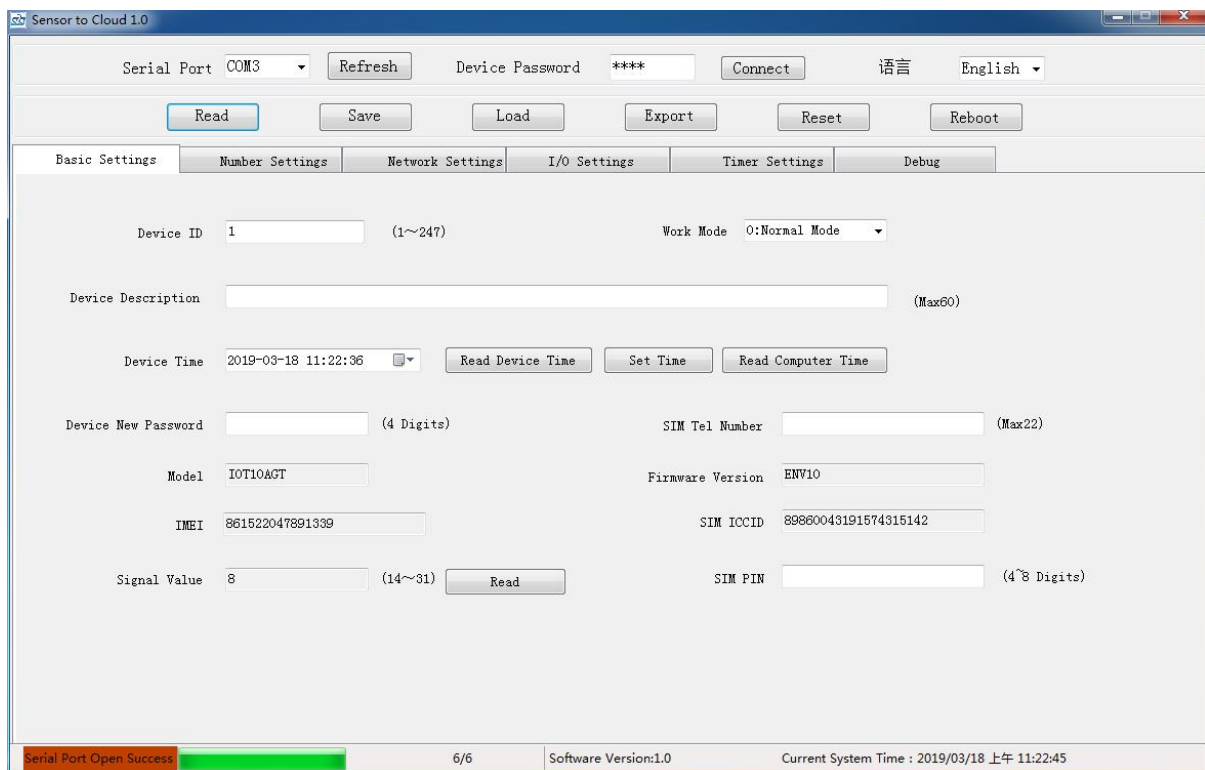

- ✧ **[Work Mode]**
 - ✓ **0: Normal Mode** (default): the device would be online all the time.
 - ✓ **1: Low Power Mode**: the device would be offline until the something happened, such as the alarm or timer task is triggered.
- ✧ **[Device ID]**



Device ID is mainly used for Modbus server center distinguishing device, range: 1~247, default 1.

✧ **[Device Description]**

Up to 60 characters, this is a description of the Device, easy to identify the use of Device.

✧ **[Device Time]**

✓ **[Read Device Time]:** read device current time.

✓ **[Set Time]:** write the setting time to the device, and this click will take effect immediately.

✓ **[Read Computer Time]:** read computer current time.

✧ **[Device New Password]**

The device password can be modified here, fixed 4 digits, the default password is 1234.

✧ **[SIM Tel Number]**

At most 22 bits

✧ **[Model]**

Display the current device model and cannot be set.

✧ **[Firmware Version]**

Displays the firmware version of the current device and cannot be set.

✧ **[IMEI]**

The module IMEI code that displays the current device and cannot be set.

✧ **[SIM ICCID]**

Displays the SIM card ICCID code in the current device, read empty without the card.

✧ **[Signal Value]**

To show the current device signal value, the normal value of the signal 14~31, the greater the value indicates the better signal. Less than 14 indicates weak signal, which may affect device communication.

✧ **[SIM PIN]**

The PIN of the SIM card, 4 to 8 digits, if the SIM card is encrypted with the PIN code, fill in the correct PIN code here to unlock it, Otherwise the device will not be able to use an encrypted SIM card.

8.4. Number Settings

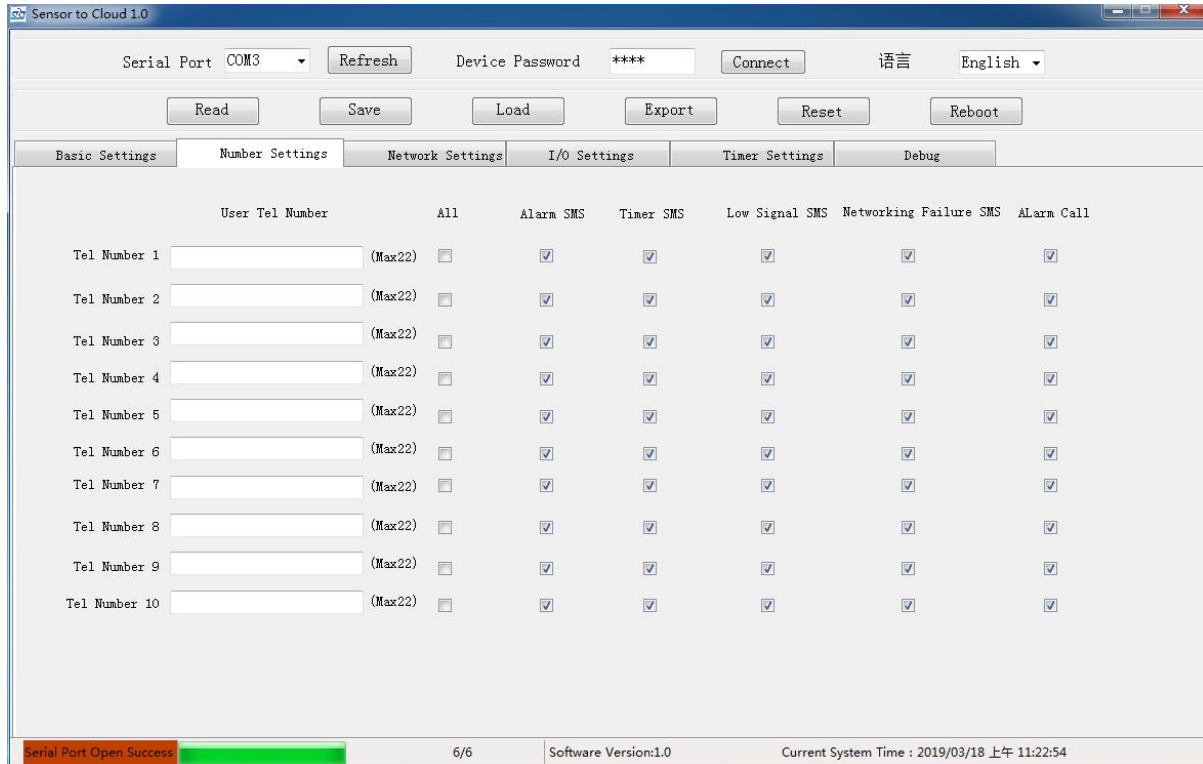

User Tel Number	All	Alarm SMS	Timer SMS	Low Signal SMS	Networking Failure SMS	Alarm Call
Tel Number 1 <input type="text"/> (Max22)	<input type="checkbox"/>	<input checked="" type="checkbox"/>	<input checked="" type="checkbox"/>	<input checked="" type="checkbox"/>	<input checked="" type="checkbox"/>	<input checked="" type="checkbox"/>
Tel Number 2 <input type="text"/> (Max22)	<input type="checkbox"/>	<input checked="" type="checkbox"/>	<input checked="" type="checkbox"/>	<input checked="" type="checkbox"/>	<input checked="" type="checkbox"/>	<input checked="" type="checkbox"/>
Tel Number 3 <input type="text"/> (Max22)	<input type="checkbox"/>	<input checked="" type="checkbox"/>	<input checked="" type="checkbox"/>	<input checked="" type="checkbox"/>	<input checked="" type="checkbox"/>	<input checked="" type="checkbox"/>
Tel Number 4 <input type="text"/> (Max22)	<input type="checkbox"/>	<input checked="" type="checkbox"/>	<input checked="" type="checkbox"/>	<input checked="" type="checkbox"/>	<input checked="" type="checkbox"/>	<input checked="" type="checkbox"/>
Tel Number 5 <input type="text"/> (Max22)	<input type="checkbox"/>	<input checked="" type="checkbox"/>	<input checked="" type="checkbox"/>	<input checked="" type="checkbox"/>	<input checked="" type="checkbox"/>	<input checked="" type="checkbox"/>
Tel Number 6 <input type="text"/> (Max22)	<input type="checkbox"/>	<input checked="" type="checkbox"/>	<input checked="" type="checkbox"/>	<input checked="" type="checkbox"/>	<input checked="" type="checkbox"/>	<input checked="" type="checkbox"/>
Tel Number 7 <input type="text"/> (Max22)	<input type="checkbox"/>	<input checked="" type="checkbox"/>	<input checked="" type="checkbox"/>	<input checked="" type="checkbox"/>	<input checked="" type="checkbox"/>	<input checked="" type="checkbox"/>
Tel Number 8 <input type="text"/> (Max22)	<input type="checkbox"/>	<input checked="" type="checkbox"/>	<input checked="" type="checkbox"/>	<input checked="" type="checkbox"/>	<input checked="" type="checkbox"/>	<input checked="" type="checkbox"/>
Tel Number 9 <input type="text"/> (Max22)	<input type="checkbox"/>	<input checked="" type="checkbox"/>	<input checked="" type="checkbox"/>	<input checked="" type="checkbox"/>	<input checked="" type="checkbox"/>	<input checked="" type="checkbox"/>
Tel Number 10 <input type="text"/> (Max22)	<input type="checkbox"/>	<input checked="" type="checkbox"/>	<input checked="" type="checkbox"/>	<input checked="" type="checkbox"/>	<input checked="" type="checkbox"/>	<input checked="" type="checkbox"/>

✧ [User Tel Number]

Each number can be set up to 22 bits, support country code, such as "+86" or "0086".

✧ [Alarm SMS / DO Change SMS]

If checked, the number will receive the alarm and recovery SMS;
The DO output model will send a DO closed or opened SMS.

✧ [Timer SMS]

If checked, the number will receive timer SMS. (The timer SMS function is in the [Timer Settings].)

✧ [Low Signal SMS]

If checked, when the device signal value is lower than 12 for more than 30 seconds, a message will be sent to inform the number.

✧ [Networking Failure SMS]

If checked, when the connection server fails, the device will send a message to inform this number.

✧ [Alarm Call]

If checked, the number will be dialed when the alarm is triggered.

The device will keep calling the next Tel number if there is not answer, until 3 times is reached.

8.5. Network Settings

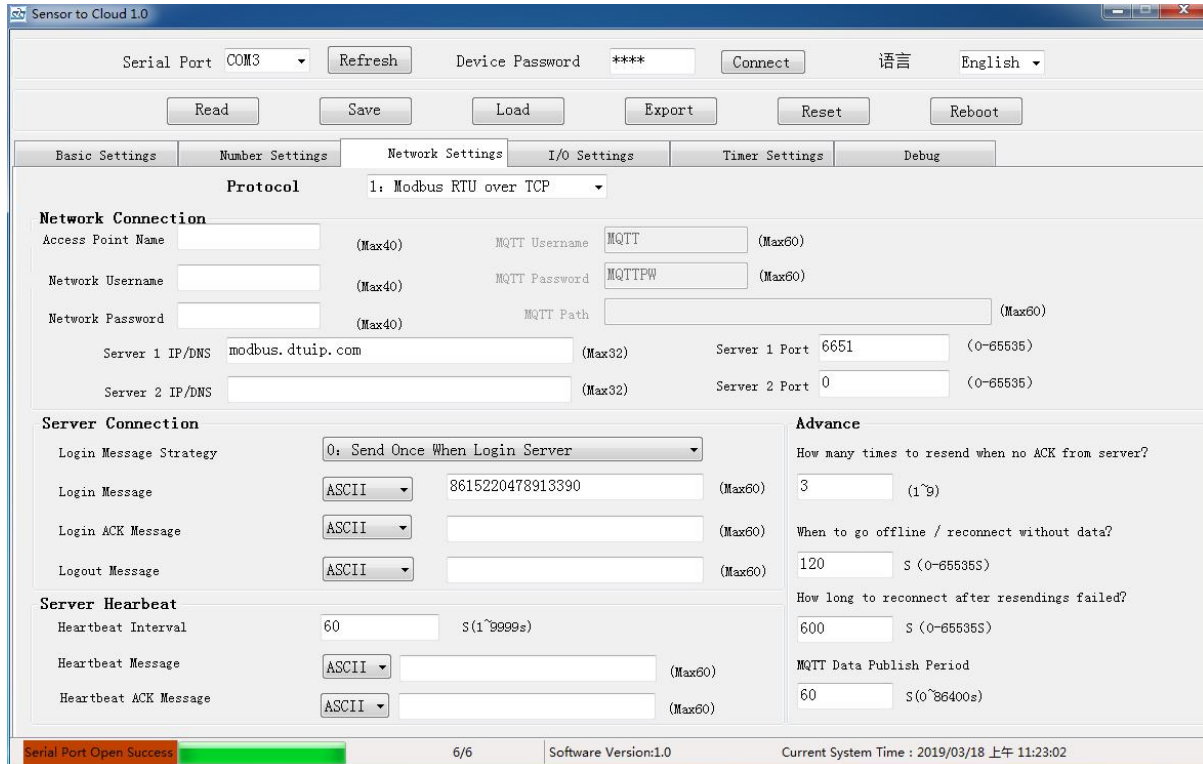

✧ [Protocol]

Select the proper protocol if you need this device to connect to the server;

When the device is Modbus RTU protocol, it will be displayed as follows:

0: Disable 1: Modbus RTU Over TCP (default) 2: Modbus RTU Over UDP

When the device is MQTT protocol, it will look like this:

0: Disable 1: MQTT (default)

✧ [Network Connection]

The SIM card access parameter can be set up to 40 characters per item, the MQTT parameter can be set up to 60 characters per item, and the server address can be set up to 32 characters per item.

✧ [APN, Username, Password]

If the access parameters of the SIM card are not available, consult the local operator for the relevant parameters.

✧ [MQTT Username, Password, Path]

MQTT protocol connection parameters

When connecting to King Pigeon cloud platform, the relevant parameters have been default. (Username is MQTT, password is MQTTPW);

To connect to your own server, set the parameters according to the protocol.

✧ [Server 1 IP/DNS, Server 1 Port]

Main server address.

If the device uses Modbus RTU protocol to connect to King Pigeon cloud platform, the server 1 is modbusrtu.kpiiot.com:4000,

If the device uses the MQTT protocol to connect to King Pigeon cloud platform, the server 1 is



mqtt.my-m2m.com: 1883;

✧ **[Server 2 IP/DNS, Server 2 Port]**

Alternate server address, when the first server address connection fails, will automatically connect to the this server address.

✧ **[Server Connection]**

Each item can be set up to 60 characters.

✧ **[Login Message Strategy]**

- ✓ 0: Send Once When Login Server
- ✓ 1: Plus it in front of Every Packet
- ✓ 2: Both of them

✧ **[Login Message]**

The registration package that the device sends to the server when connecting the server; This item is the MQTT Client Identifier and Topic Name when the device is the MQTT protocol; The default is to connect our cloud platform registration code (registration code to be valid after the background binding, if invalid, please contact after-sales), if necessary to connect to our cloud platform, do not modify.

✧ **[Login ACK Message]**

The server responds to the registered package (downlink): if this item is set, the server must issue the corresponding data to the device when registering the connection server; otherwise the device is considered to have failed to register the connection.

✧ **[Logout Message]**

The server disconnects the connected package (downlink): the device will automatically disconnect when it receives this data from the server.

✧ **[Server Heartbeat]**

Each item can be set up to 60 characters.

✧ **[Heartbeat Interval]**

Heartbeat package send cycle: range 0~9999 seconds, set to 0 means not to send, default 60 seconds.

✧ **[Heartbeat Message]**

The device sends the server a heartbeat package to maintain the connection.

✧ **[Heartbeat ACK Message]**

The server responds to heartbeat package (downlink): if this item is set, the server must send the corresponding data to the device when receiving the heartbeat package. The connection will be disconnected if the device does not receive this data more than three times.

✧ **[ASCII], [HEX]**

Data format, ASCII character or Hexadecimal data, please select according to server protocol.

✧ **[Advance]**

✧ **[How many times to resend when no ACK from server?]**

Range 1~9, default 3, it means when the device sends data to the server, the server does not respond and will repeat sending 3 times.

✧ **[When to go offline / reconnect without data?]**

Range 0~65535 seconds, default 120 seconds, it means the server has not sent data to the device for a continuous period of 120 seconds, in normal mode, the device will take the initiative to offline and then reconnect the server. And in low power mode, the RS485 serial port transmission type device will be directly offline and close the module to sleep. (This item of other types of Device does not work in low

power mode).

✧ **[How long to reconnect after resending failed?]**

Interval reconnection cycle: Range 0-65535, by default 600 seconds, indicates that the device will try again after 600 seconds interval after the server has not responded after the relaunch. This item is effective in normal mode and does not work in low power mode.

✧ **[MQTT Data Publish Period]**

This item is valid only when the device is the MQTT protocol, range 0~86400 seconds (1 day), default 60 seconds, indicates that every 60-second, device will upload data to the server.

8.6. I/O Settings

The I/O parameter page displays different parameter settings pages according to the device model.

8.6.1. DO - Digital Output (Open Collector) Settings

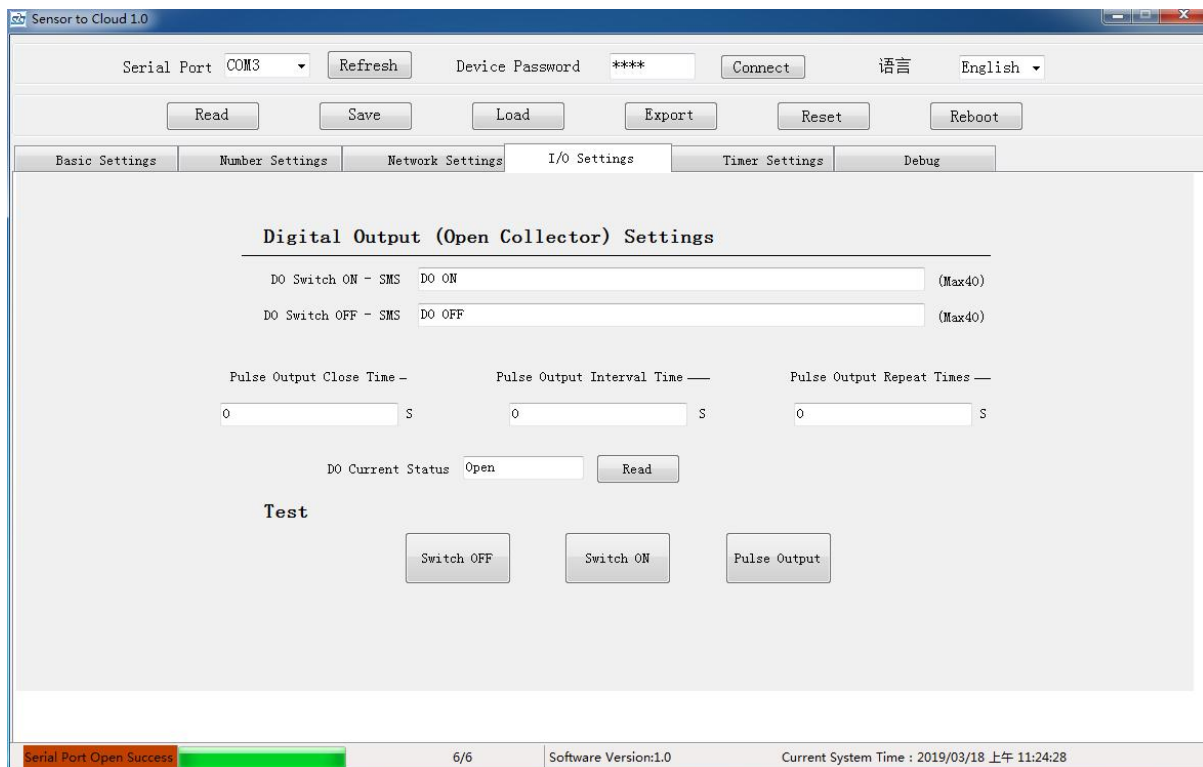

✧ **[DO Switch ON - SMS Content]**

The SMS content sent to the authorization number when DO closed.

✧ **[DO Switch OFF - SMS Content]**

The contents of messages sent to the authorized number when DO is opened.

✧ **[Pulse Output Close Time]**

Range 0~65535 seconds, default 0, it indicating that the pulse output is always closed.

✧ **[Pulse Output Interval Time]**

Range 0~65535 seconds, default 0.

✧ **[Pulse Output Repeat Times]**

Range 0~65535 times, default 0.

✧ **[DO Current Status]**

Click read to display DO current status.

✧ **[Test]**

[Switch OFF]: DO output open immediately after clicking.

[Switch ON]: DO output close immediately after clicking.

[Pulse Output]: DO pulse output after clicking.

8.6.2.DIN - Digital Input Settings

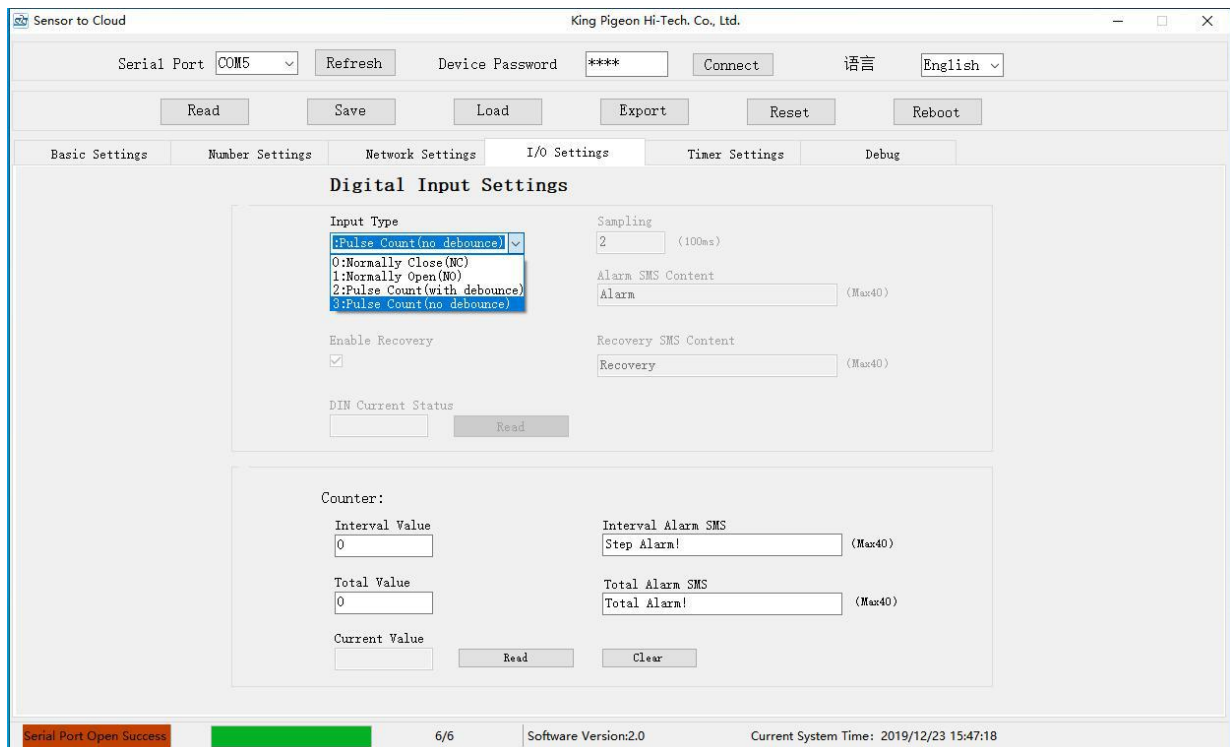

✧ **[Input Type]: Default is NO**

- ✓ **0: Normal Close (NC):** DIN is normally close, alarm when DIN is open.
- ✓ **1: Normal Open (NO):** DIN is normally open, alarm when DIN is close.
- ✓ **2:Pulse Counter(Debounce),**max pulse frequency 50Hz.
- ✓ **3:Pulse Counter(No Debounce),**max pulse frequency 1KHz.

✧ **[Sampling period]**

Range 2-65535, unit 100ms (0.1 second), default is 2, indicating that the DIN state is collected every 200 milliseconds (0.2 seconds). In low power mode, it is recommended to extend the sampling period according to actual needs, which can reduce power consumption.

✧ **[Alarm/Recovery Verify Time]**

Range 0-65535 seconds, default is 2, stands for DIN status changed,will delay 2 seconds to confirm alarm or recovery,which can prevent false alarms. Set to 0 indicates that the SMS will be sent immediately when DIN changed.

✧ **[Alarm SMS Content],[Recovery SMS Content]**

Up to 40 characters, the SMS content sent to the authorized number when DIN alarmed or returned



to normal.

✧ **[Enable Recovery Inform]**

If checked, the device will send a message to the authorized number when DIN returns to normal.

✧ **[DIN Current Status]**

Click to read and display DIN current status.

✧ **[Interval value]**

Alarm will be triggered every time the count reaches the interval value.

✧ **[Total value]**

When the count reaches the total value, it will alarm and restart counting from 0 (if the total value is not set, it will restart counting from 0 when the maximum count value reaches 4,294,967,295).

✧ **[Interval Alarm SMS],[Total Alarm SMS]**

Up to 40 characters, the SMS content sent to the authorized number.

✧ **[Read]**

Click to read current value

✧ **[Clear]**

Click to clear count

8.6.3.AIN - Analog Input Settings

The screenshot displays the 'Analog Input Settings' window in the 'Sensor to Cloud 1.0' application. The window has a title bar and a menu bar with options like 'Basic Settings', 'Number Settings', 'Network Settings', 'I/O Settings', 'Timer Settings', and 'Debug'. The 'I/O Settings' tab is active. The settings are organized into several sections: 'Sampling Period' (10, 100MS), 'Alarm/Recovery Verify Time' (2, MS), 'Measuring Range (-32767~32767)' with 'Minimum' (40) and 'Maximum' (200) fields, 'Current Value' (4) with a 'Read' button, 'Threshold High' (0) with 'High Alarm SMS' (High Alarm) and '(MAX40)', 'Threshold Low' (0) with 'Low Alarm SMS Content' (Low Alarm) and '(MAX40)', and 'Enable Recovery Inform' (checked) with 'Recovery SMS Content' (Recovery) and '(MAX40)'. A status bar at the bottom shows 'Serial Port Open Success' with a green progress bar, '6/6', 'Software Version:1.0', and 'Current System Time : 2019/03/18 上午 11:25:49'.

✧ **[Sampling Period]**

Range 2-65535, unit 100ms (0.1 second), by default 10, indicating that the AIN value is collected every 1000 milliseconds (1 second). In low power mode, it is recommended to extend the sampling period according to actual needs, which can reduce power consumption.

✧ **[Alarm/Recovery Verify Time]**

Range 0~65535 seconds, by default 2, indicates that the value exceeds the threshold for 2 seconds

before it is confirmed as alarm or recovery, it can prevent misreporting. Set to 0 means that, if the value of AIN exceeds the threshold, the alarm will be made immediately.

✧ **[Minimum],[Maximum]**

The sensor's maximum & minimum measure range. E.g.:0~100 Celsius degree. Usually it can be found out at the sensor's specification.

Note: Measuring range minimum and maximum, are integer, it is 10 times the real value.

Such as, the specification of the sensor shows that the range of the sensor is -40 to 200, and then you need to set the range minimum to -400, set the range maximum to 2000.

✧ **[Current Value]**

Click read to display AIN current value.

✧ **[Threshold High], [Threshold Low]**

When the current value is between these two values, it is normal; otherwise there will be alarm;

Note: Threshold high and threshold low are integer; it is 10 times the real value.

Such as you want to set the threshold low to -12.3, threshold high to 45.6, you need to enter low -123 and high 456.

✧ **[High Alarm SMS Content],[Low Alarm SMS Content],[Recovery SMS Content]**

This device allows you to customize the content. Support up to 40 characters, the SMS content sent to the authorized number when AIN alarmed or returned to normal.

✧ **[Enable Recovery Inform]**

If checked, the device will send a message to the authorized number when AIN returns to normal.

8.6.4.DS18B20 Temperature Settings

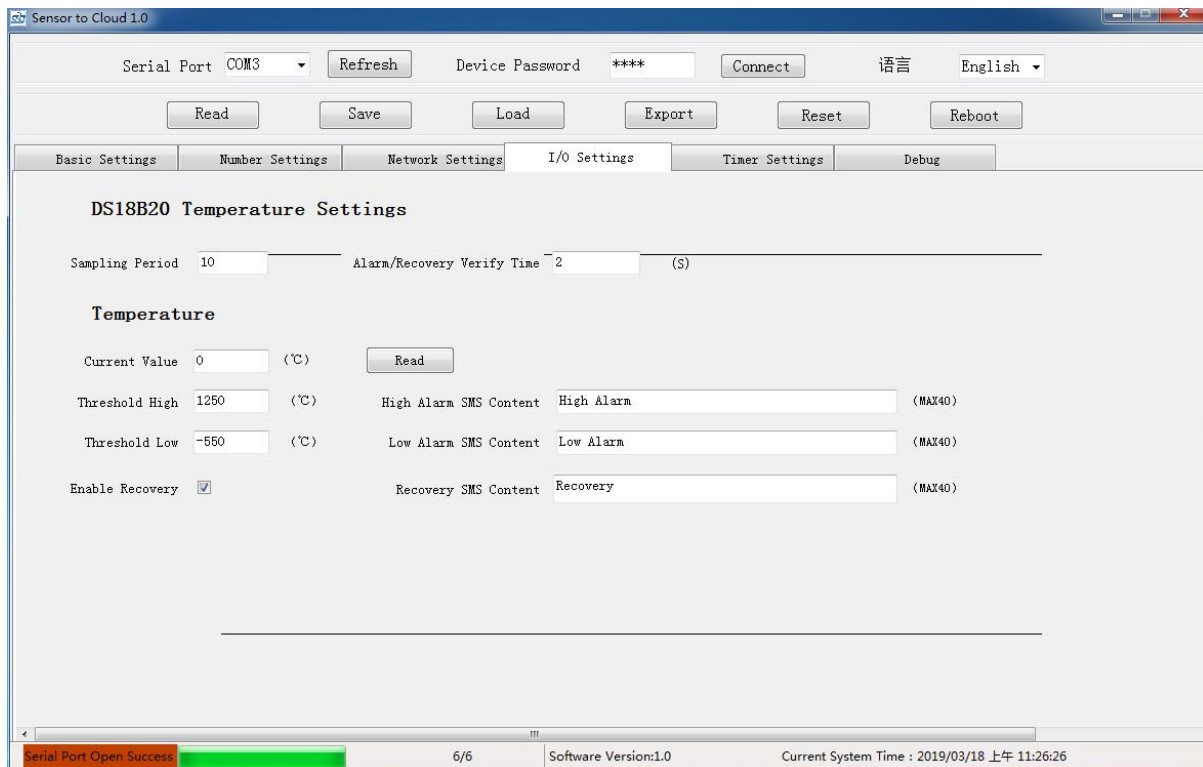

✧ **[Sampling Period]**

Range 2-65535, unit 100ms (0.1 second), by default 10, indicating that the DS18B20 temperature is



collected every 1000 milliseconds (1 second). In low power mode, it is recommended to extend the sampling period according to actual needs, which can reduce power consumption.

✧ **[Alarm/Recovery Verify Time]**

Range 0~65535 seconds, by default 2, indicates that the temperature exceeds the threshold for 2 seconds before it is confirmed as alarm or recovery, it can prevent misreporting. Set to 0 means that, if the temperature exceeds the threshold, the alarm will be made immediately.

✧ **[Current Value]**

Click read to display current temperature.

✧ **[Threshold High], [Threshold Low]**

When the current temperature is between these two values, it is normal; otherwise there will be alarm;

Note: Threshold high and threshold low are integer; it is 10 times the real value.

Such as you want to set the threshold low to -12.3°C, threshold high to 45.6°C, you need to enter low -123 and high 456.

✧ **[High Alarm SMS Content],[Low Alarm SMS Content],[Recovery SMS Content]**

This device allows you to customize the content. Support up to 40 characters, the SMS content sent to the authorized number when temperature alarmed or returned to normal.

✧ **[Enable Recovery Inform]**

If checked, the device will send a message to the authorized number when temperature returns to normal.

8.6.5.AM2301 Temperature & Humidity Settings

Serial Port COM3 Refresh Device Password **** Connect 语言 English

Read Save Load Export Reset Reboot

Basic Settings Number Settings Network Settings I/O Settings Timer Settings Debug

AM2301 Temperature Humidity Settings

Sampling Period 10 (100MS) Alarm/Recovery Verify 2 (S)

Temperature

Current Value 0 (°C) Read

Threshold High 800 (°C) High Alarm SMS Content High Alarm

Threshold Low -400 (°C) Low Alarm SMS Content Low Alarm

Enable Recovery Recovery SMS Content Recovery

Humidity

Current Value 0 (%RH) Read

Threshold High 100 (%RH) High Alarm SMS Content High Alarm

Threshold Low 0 (%RH) Low Alarm SMS Content Low Alarm

Enable Recovery Recovery SMS Content Recovery

Serial Port Open Success 6/6 Software Version:1.0 Current System Time : 2019/03/18 上午 11:29:09

✧ **[Sampling Period]**

Range 2-65535, unit 100ms (0.1 second), by default 10, indicating that the AM2301 temperature &



humidity is collected every 1000 milliseconds (1 second). In low power mode, it is recommended to extend the sampling period according to actual needs, which can reduce power consumption.

✧ **[Alarm/Recovery Verify Time]**

Range 0~65535 seconds, by default 2, indicates that the temperature or humidity exceeds the threshold for 2 seconds before it is confirmed as alarm or recovery, it can prevent misreporting. Set to 0 means that, if the temperature or humidity exceeds the threshold, the alarm will be made immediately.

✧ **[Current Value]**

Click read to display current temperature or humidity.

✧ **[Threshold High], [Threshold Low]**

When the current temperature or humidity is between these two values, it is normal; otherwise there will be alarm;

Note: Threshold high and threshold low are integer; Threshold of temperature is 10 times the real value. Humidity is already real value, so threshold of humidity don't need to change.

Such as, if you want to set the threshold low of temperature to -12.3°C , threshold high of temperature to 45.6°C , you need to enter low -123 and high 456.

If you want to set the threshold of humidity to 20%RH~60%RH, then you need to set threshold low to 20 and threshold high to 60.

✧ **[High Alarm SMS Content],[Low Alarm SMS Content],[Recovery SMS Content]**

This device allows you to customize the content. Support up to 40 characters, the SMS content sent to the authorized number when temperature alarmed or returned to normal.

✧ **[Enable Recovery Inform]**

If checked, the device will send a message to the authorized number when temperature returns to normal.



8.6.6.RS485 Settings

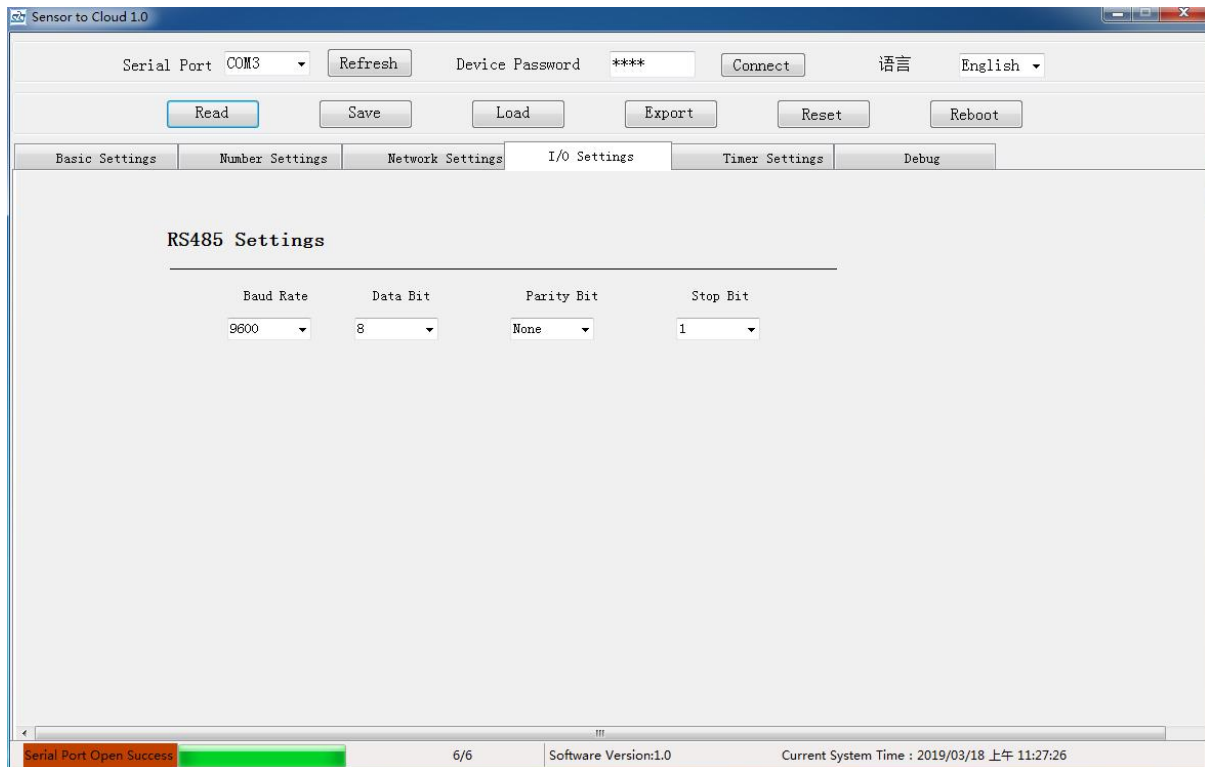

- ✧ [Baud Rate]: Optional 115200, 57600, 38400, 19200, 9600, 4800, 2400, 1200, default 9600
- ✧ [Data Bit]: Optional 8, 9, default 8
- ✧ [Parity Bit]: Optional None, Even, Odd, default None
- ✧ [Stop Bit]: Optional 1, 2, default 1

Note: Make sure that RTU device and the device which connected to RTU through RS485, these 2 devices has the same RS485 parameters, otherwise they could not communicate.

8.7. Timer Settings

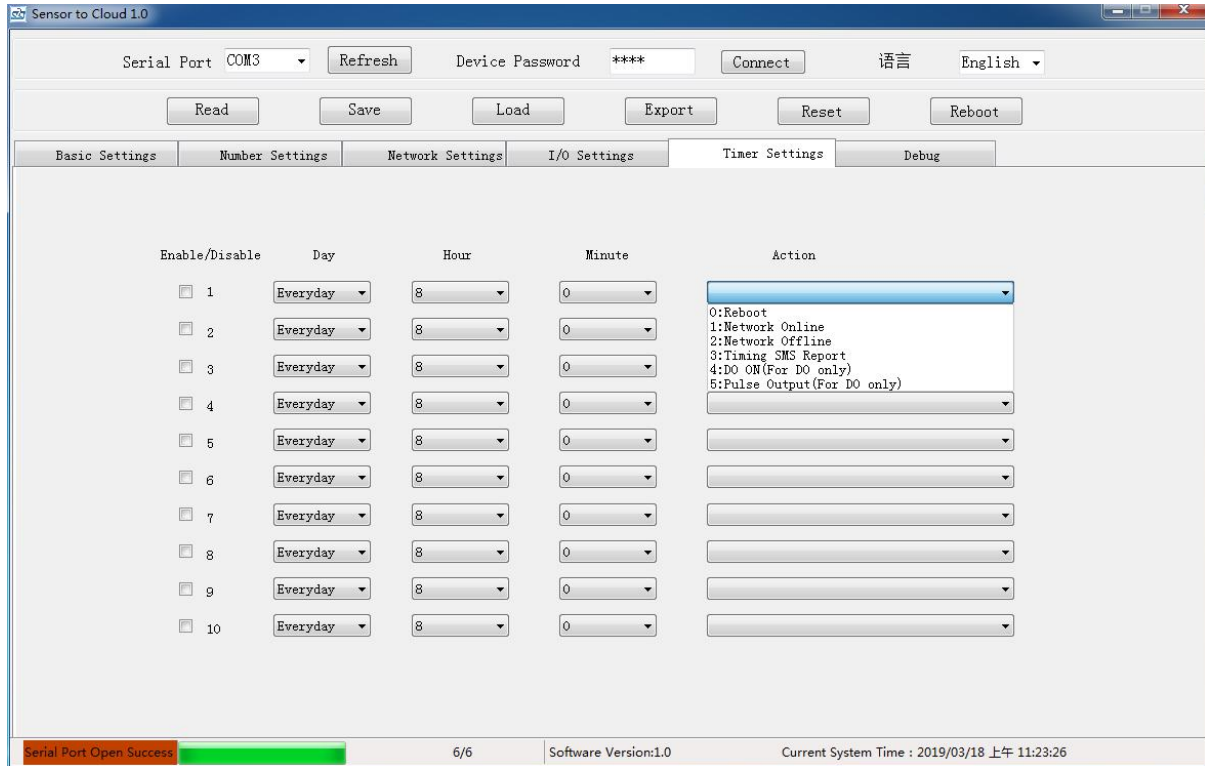

This page is used to manage the timer tasks, the following actions are supported.

Action	Description
0: Reboot	Reboot the device.
1: Network Online	Enable the network and connect to the server.
2: Network Offline	Disconnect from the server
3: Timing SMS Report	Send SMS to users who have enabled the Timer SMS in [Number Settings]. It is about the current status of the device.
4: DO ON(For DO only)	Only device of the DO output is valid. DO output will always close.
5: Pulse Output(For DO only)	Only device of the DO output is valid. DO pulse output, and pulse output parameters could be set on the [I/O Settings – DO Settings] page.

8.8. Debug

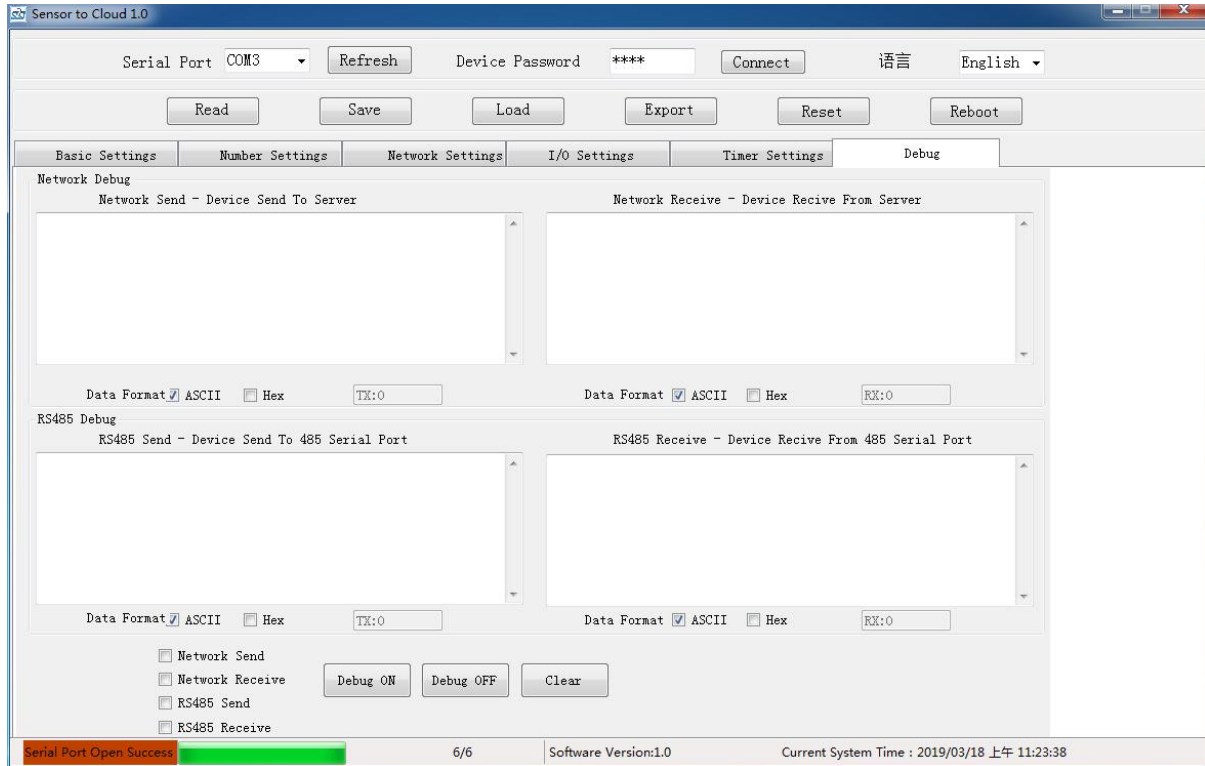

This function allows you to monitor the data:

- (1) The data sent and received between the device and the server.
- (2) The data sent and received from machine to machine (for RS485 serial port transmission device).

9. SMS Instructions

This device supports SMS Instructions. You could change the settings, query the current value and control the device through SMS instructions. All the SMS instructions are as follows.

Tip:

- (1) The device's default password is 1234, and you can send the SMS Instruction to modify the password.
- (2) The "password" in the following instructions refers to the device password.
- (3) The "+" number that appears in the following note is not an instruction.
- (4) If a symbol appears in the instruction, it must be entered under the English input method.
- (5) Unless otherwise specified, the letters in the instruction must be capital letters such as "PWD" and not "pwd".
- (6) If the password is entered correctly and the instruction is entered incorrectly, the device will return the message: "SMS Format Error, Please check Caps Lock in Command!" Please check whether the



Chinese and English input method or case is correct.

- (7) If the password is entered incorrectly, no information is returned.
- (8) The device will return a confirmation message after receiving the message instruction, and if no return information is available, please check the password and the signal is normal.

SMS Instructions

9.1. Set new password

Instructions		Return
Set	Password+P+new password Note: the password is a 4 digit integer, default is 1234. Example Instruction: 1234P4321	[New password], This is the New Password, please remember it carefully.

9.2. Set the SIM card number

(For automatic calibration of time on device every time the device boots.)

Instructions		Return
Set	Password+TEL+x+# Note: x is the device number, that is, the SIM card number installed in the device, which supports up to 22 bits. Example: the Device number is 18812345678, instruction 1234TEL18812345678 # (Please pay attention to reset when replacing SIM card.)	Set successfully

9.3. Set time of device

Instructions		Return
Set	Password+Dxxyyzz+Thhmm Note: xx (year), yy (month), zz (day), hh (hour), mm (minute) Example: set Jan. 2, 2019 at 03:04, instruction 1234D190102T0304	20xx(Y)yy(M)zz(D)hh(H)mm(M)
Inquiry	Password+D	

9.4. Set the user Tel number

Instructions		Return
Set	Password+A+x+T+y Note: x is serial number, range 01~10, 2 digits; y is the user Tel number, can support up to 22 bits, support country code, such as +86 or 0086. Example: 1234A01T18812345679	Tel1: Tel2: ... Tel10:
Inquiry	Password+A	



Delete	Password+A+x	
--------	--------------	--

9.5. Query device status

Instructions		Return
Inquiry	Password+EE Note: different types of returns vary in content.	[Device description] 19-01-23 12: 34 Device ID: 1 IMEI: 864507039876957 Signal value: 31 DIN: ON/OFF Working Mode: Normal Mode / Low Power Mode Model: IOT10DGT Version: ENV10

9.6. Set working mode

Instructions		Return
Set	Password+MOD+x Note: x is 0 or 1; 0 represents normal mode, and 1 represents low power mode Example: <code>1234MOD1</code>	Working Mode: Normal Mode / Low Power Mode

9.7. Set Device ID

Instructions		Return
Set	Password+ID+x Note: x is 1~247, default 1 Example: <code>1234ID1</code>	ID: x
Inquiry	Password+IDE	

9.8. Set network parameter of SIM card

Instructions		Return
Set	Password+AP+x#+y#+z Note: x is Access Point Name(APN), y is username, z is password; Each item can be set up to 40 characters. Example: <code>1234APpoint#user#apnpwd</code>	APN: x User Name: y Password: z
Inquiry	Password+AP	
Delete	Password+APDEL	



9.9. Set server parameters

Instructions		Return
Set	Server 1: Password+IP+x+*+y Server 2: Password+IPB+x+*+y Note: x is a server IP or domain name that can be set up to 32 characters; y for port number, range 0-65535 Example: connect to King Pigeon cloud platform www.kpiiot.com <u>1234IPmodbusrtu.kpiiot.com*4000</u>	Domain/Server IP: x Port: y
Inquiry	Server 1: Password+IP Server 2: Password+IPB	
Delete	Server 1: Password+IPDEL Server 2: Password+IPBDEL	

9.10. Enable/Disable network

Instructions		Return
Online (enable transmission protocol)	Password+GPRSONline Example: <u>1234GPRSONline</u>	GPRS Online
Offline (disable transmission protocol)	Password+GPRSOFF Example: <u>1234GPRSOFF</u>	Disabled GPRS

9.11. Set Login Message

Instructions		Return
Set	Password+RTP+x Note: x is the contents of the registered package, which can be set up to 60 characters. Example: <u>1234RTP1234567890</u>	Registration package: x
Inquiry	Password+RTE	

9.12. Set Heartbeat Message (only for Modbus protocol)

Instructions		Return
Set	Password+HET+x Note: x is the contents of the heartbeat package, which can be set up to 60 characters. Example: <u>1234HETrequent</u>	Heartbeat package content: x
Inquiry	Password+HEE	



9.13. Set the Heartbeat Interval

Instructions		Return
Set	Password+HT+x Note: x is 0~9999, unit second, default 60, set to 0 to indicate disable Example: <code>1234HT60</code>	Heart Pack Period: x(S)
Inquiry	Password+HTE	

9.14. Set DO output parameters (only for DO output)

Instructions		Return
DO output close	Password+DOC	DO: ON / OFF
DO output open	Password+DOO	
Query the current state	Password+DOE	
Pulse output close time	Password+DOT+x Note: x is 0-65535, unit second, default 0, indicating that the pulse output is always closed.	DO Pulse Output Time: 0(s)
Query pulse close time	Password+DOT	
Control pulse output	Password+DOP	DO Pulse Output

9.15. Set threshold high and low (only for AIN, DS18B20, AM2301 input)

Instructions		Return
Set	Password+AINR+x+L+y+H+z# Note: x is 1 or 2,(1 represents AIN or temperature, 2 represents humidity); y for threshold low, z for threshold high; To have a higher accuracy, the device uses a number which is 10 times of the real value to represent the value of AIN/DS18B20 temperature/AM2301 temperature(Except Humidity); for example, the device uses the 1000 to represent 100°C; AM2301 humidity setting range 0~100, corresponding 0~100%RH; Example: setting temperature low -12.3°C, high 45.6°C, instruction <code>1234AINR1L-123H456#</code> Set humidity low limit 20%RH, high limit 60%RH, instruction <code>1234AINR2L20H60#</code>	AIN: Low: y, High: z Temperature: Low: y, High: z Humidity: Low: y, High: z
Inquiry	Password+AINR	



9.16. Set the range of AIN (only for AIN input)

Instructions		Return
Set	Password+AINM+L+y+H+z+# Note: y is the minimum, z is the maximum, set range-32767-32767, corresponding to-3276.7-3276.7; Set to 10 times the actual value. Example: setting minimum value -12.3, maximum value 45.6, instruction <code>1234AINML-123H456#</code>	AIN: min: y, max: z
Inquiry	Password+AINM	

9.17. Calibrate the accuracy of AIN (only for AIN input)

Instructions		Return
Set	Password+VOL=x Note: x is the calibration value, generally 3200~3400; The factory accuracy is calibrated and please do not set it if no necessary. If recalibration is required, please first inquiry the calibration value and set it on the original basis: Increase the calibration value to increase the AIN measurement value, decrease the calibration value to decrease the AIN measurement value; For example, if the factory calibration value is 3315: if the AIN measurement value is smaller than the actual value, you can try to increase the calibration value like 3325, 3335, 3345... if the AIN measurement value is larger than the actual value, you can try to decrease the calibration value like 3305, 3295, 3285... Example: set the calibration value to 3300, instruction <code>1234VOL=3300</code>	VOL: x
Inquiry	Password+VOL	

9.18. Delete cache data

Instructions		Return
Delete	Password+HISDEL	Delete successfully

Note:

Caching data refers to a device of the MQTT protocol model or RS485 serial port model.

Cache Data is the data which is failed to send to the server, include the data haven't got the ACK from the server.

Caching data will exist even if the device rebooted, and it will be removed successfully until the device making sure that every piece of data is uploaded to the server effectively.

So make sure that the cache data is no longer used before deleting it.

9.19. Reboot Device

Instructions		Return
Remote restart	Password+REBOOT	Reboot successfully

9.20. Restore factory settings

Instructions		Return
Restore factory settings	Password+RESET	Reset successfully!

9.21. Set device language

Instructions		Return
Set to Chinese	Password+CH	中文
Set to English	Password+EN	English

9.22. Clear DIN Pulse Counter(Only for DIN)

Instructions		Return
Clear counter	Password+PDEL	Set successfully

10. Transmission protocol

This product supports the transmission of data to the server via the network and supports the Modbus RTU and MQTT protocols. Reference is made to the specific communication rules of the Modbus RTU protocol and the MQTT protocol.

10.1. Modbus RTU protocol

The Modbus RTU protocol used in this product is essentially a transmission of a Modbus RTU communication instruction on the basis of the TCP or UDP protocol. The device is a TCP/UDP client.

10.1.1. Modbus address and example of DO types

Register address	Definition	Data type	Function code	Data description
0	DO output state	bit	1 / 5	0 is open, 1 is close

Example:

Server query DO status Modbus message (Hexadecimal representation): 01 01 00 00 00 01 FD CA

Issue data	Detailed description
01	Device ID address
01	Function code 01, reading DO state
00 00	Reads data from the device register address, 00 00
00 01	Read the number of 1
FD CA	CRC validation

Device return Modbus message: 01 01 01 00 51 88

Return data.	Detailed description
01	Device ID address
01	Function code 01
01	The data returned is 1 byte in length.
00	The data returned is 0 (0 for open, 1 for close)
51 88	CRC validation

Server control DO Close/Open Modbus message: 01 05 00 00 FF 00 8C 3A or 01 05 00 00 00 00 CD CA

Issue data	Detailed description
01	Device ID address
05	Function code 05, control DO state
00 00	Register address:
FF 00 / 00 00	Perform the action (FF 00 means close relay, 00 00 means open relay)
BC 3A / CDCA	CRC validation

The response Modbus message is the same to the request message.

10.1.2. Modbus address and example of DIN types

Register address	Definition	Data type	Function code	Data description
0	DIN input state	bit	2	0 is open, 1 is close
0(High)	DIN pulse count	32 bit Unsigned integer ABCD	Read:3,4	Actual value = register value
1(Low)			Write:16	

Example:

Server query DIN status issue data: 01 02 00 00 00 01 B9 CA

Issue data	Detailed description
01	Device ID address
02	Function code 02, reading DIN state
00 00	Reads data from the device register address 00 00.
00 01	Read the number of 1.
B9 CA	CRC validation

Device return data: 01 02 01 00 A1 88



Return data.	Detailed description
01	Device ID address
02	Function code 02
01	The data returned is 1 byte in length.
00	The data returned is 0 (0 for open, 1 for close)
A1 88	CRC validation

10.1.3. Modbus address and example of AIN types

Register address	Definition	Data type	Function code	Data description
0	AIN input value	16-bit sign integer.	4	Real value = Register value/10

Example:

Server query AIN values data: 01 04 00 00 00 01 31 CA

Issue data	Detailed description
01	Device ID address
04	Function code 04, reading AIN values
00 00	Reads data from the device register address, 00 00.
00 01	Read the number of 1.
31 CA	CRC validation

Device return data: 01 04 02 00 7B F9 13

Return data.	Detailed description
01	Device ID address
04	Function code 04
02	The data returned is 2 bytes in length.
00 7B	The data returned is 00 7B (real value = register value/10, hexadecimal number 7B is equal to decimal number 123, so the real value is 123/10 = 12.3)
F9 13	CRC validation

10.1.4. Modbus address and example of DS18B20 types

Register address	Definition	Data type	Function code	Data description
0	DS18B20 temperature	16-bit sign integer.	4	Real value = register value/10

Example:

Server query DS18B20 data: 01 04 00 00 00 01 31 CA

Issue data	Detailed description
01	Device ID address
04	Function code 04, reading DS18B20 temperature
00 00	Reads data from the device register address, 00 00.

00 01	Read the number of 1.
31 CA	CRC validation

Device return data: 01 04 02 01 C8 B9 36

Return data.	Detailed description
01	Device ID address
04	Function code 04
02	The data returned is 2 bytes in length.
01 C8	The data returned is 01 C8 (real value = register value/10, hexadecimal number 01 C8 equals decimal number 456, so the real temperature is $456/10 = 45.6^{\circ}\text{C}$)
B9 36	CRC validation

10.1.5. Modbus address and example of AM2301 types

Register address	Definition	Data type	Function code	Data description
0	AM2301 temperature	16-bit sign integer.	4	Real value = register value/10
1	AM2301 humidity	16-bit sign integer.	4	Real value = register value

Example:

Server query AM2301 Temperature & Humidity data: 01 04 00 00 00 02 71 CB

Issue data	Detailed description
01	Device ID address
04	Function code 04, reading AM2301 temperature & humidity
00 00	Reads data from the device register address, 00 00.
00 02	Read the number of 2.
71 CB	CRC validation

Device return data: 01 04 04 00 7B 00 2D 4B 80

Return data.	Detailed description
01	Device ID address
04	Function code 04
04	The data returned is 4 bytes in length.
00 7B 00 2D	The data returned are Temperature < 00 7B >, Humidity < 00 2D >. The real temperature = register value/10, hexadecimal number 7B is equal to decimal number 123, so the real temperature is $123/10 = 12.3^{\circ}\text{C}$ The humidity is equal to the original value of the register, the hexadecimal number 2D is equal to the decimal number 45, so the humidity is 45%RH
4B 80	CRC validation



10.2. MQTT Protocol

When the device connects to King Pigeon cloud platform with MQTT, the user could use it immediately, don't need to care about the MQTT protocol. If you need to connect to your own server, the following is the protocol for you.

10.2.1. MQTT data format published by DO types

Device publish topic: device serial number (data filled out in the 'Login Message' for the 'Network Settings' on the configuration software)

```
{
  "sensorDatas":
  [
    {
      "addTime": "2019-01-02 12:34:56", // timestamp
      "switcher": "0", // switch type data, 0 is open, 1 is close
      "flag": "DO1" // DO identification
    }
  ]
}
```

Platform Control DO Data Format:(The device must subscribe to the platform before the platform can control the DO)

Device publish topic: device serial number/+ (To subscribe to a topic, add the wildcard "/" "+" after the serial number)

```
{
  "sensorDatas":
  [
    { //Comments, not included in the data
      "sensorId": 211267, // Sensor ID on cloud platform
      "switcher": "1", // switch type data, 0 is open, 1 is close
      "flag": "DO1" // DO identification
    },
    "down":"down" // Platform Down Message
  ]
}
```

10.2.2. MQTT data format Published by DIN Type

DIN NO and NC function release data format

Device subscribe topic: device serial number/+ (parameter "login message" on the configuration software)

```
{
```



```
"sensorDatas":
[
  {
    // Comments, not included in the data
    "addTime":"2019-01-02 12:34:56", // Timestamp
    "switcher":1, // switch type data, 0 is open, 1 is close
    "flag":"DI1" // DIN identification
  }
]
}
```

DIN pulse counting function releases data format

Device publish topic: device serial number (data filled out in the 'Login Message' on the configuration software)

```
{
  "sensorDatas":
  [
    {
      "addTime":"2019-01-02 12:34:56", // timestamp
      "value":"1", // Numeric data
      "flag":"COUNT" // DIN pulse counting identification
    }
  ]
}
```

10.2.3.MQTT data format published by AIN types

Device publish topic: device serial number (data filled out in the 'Login Message' for the 'Network Settings' on the configuration software)

```
{
  "sensorDatas":
  [
    {
      "addTime":"2019-01-02 12:34:56", // timestamp
      "value":"12.3", // numerical type data
      "flag":"AI1" // AIN identification
    }
  ]
}
```



10.2.4. MQTT data format published by DS18B20 types

Device publish topic: device serial number (data filled out in the 'Login Message' for the 'Network Settings' on the configuration software)

```
{
  "sensorDatas":
  [
    {
      "addTime":"2019-01-02 12:34:56", // timestamp
      "value":"12.3", // numerical type data
      "flag":"T1" // temperature identification
    }
  ]
}
```

10.2.5. MQTT data format published by AM2301 types

Device publish topic: device serial number (data filled out in the 'Login Message' for the 'Network Settings' on the configuration software)

```
{
  "sensorDatas":
  [
    {
      "addTime":"2019-01-02 12:34:56", // timestamp
      "value":"12.3", // numerical type data
      "flag":"T1" // temperature identification
    },
    {
      "addTime":"2019-01-02 12:34:56", // timestamp
      "value":"45", // numerical type data
      "flag":"H1" // humidity identification
    }
  ]
}
```

11. Warranty

This product provides quality assurance for ONE year, but does not include any malfunctions caused by damage or improper operation.



12. Appendix A - SMS Instructions Table

Function		SMS Instructions	Remark
Set new password		Password + P + 'new password'	Default password: 1234
Set the SIM card number		Password + TEL + 'SIM card number' + #	For automatic calibration of time on device.
Set time of device		Password + D + 'year, month, day' + T + 'hour, minute'	Year, month, day, hour, minute, each have two digits.
Inquiry time of device		Password + D	
Set the user Tel number		Password + A + 'serial number' + T + 'user Tel number'	The serial number range 01~10, 2 digit.
Inquiry the user Tel number		Password + A	
Delete the user Tel number		Password + A + 'serial number'	
Query device status		Password + EE	
Set to normal mode		Password + MOD0	
Set to low power mode		Password + MOD1	
Set Device ID		Password + ID + 'ID number'	The ID number is 1~247, default 1.
Inquiry Device ID		Password + IDE	
Set network parameter of SIM card		Password + AP + 'Access Point Name' + # + 'username' + # + 'password'	
Inquiry network parameter		Password + AP	
Delete network parameter		Password + APDEL	
Set server parameters	IP1	Password + IP + 'IP address or domain name' + * + 'port number'	The server 1 is main server, server 2 is alternate server.
	IP2	Password + IPB + 'IP address or domain name' + * + 'port number'	
Inquiry server parameters	IP1	Password + IP	
	IP2	Password + IPB	
Delete server parameters	IP1	Password + IPDEL	
	IP2	Password + IPBDEL	
Enable network - Online		Password + GPRSONLINE	Enable transmission protocol
Disable network - Offline		Password + GPRSOFF	Disable transmission protocol
Set Login Message		Password + RTP + 'Login Message'	
Inquiry Login Message		Password + RTE	
Set Heartbeat Message		Password + HET + 'Heartbeat Message'	Only for Modbus protocol
Inquiry Heartbeat Message		Password + HEE	
Set the Heartbeat Interval		Password + HT + 'interval time'	The Interval time is 0~9999, unit second, default 60.
Inquiry the Heartbeat Interval		Password + HTE	
DO output close		Password + DOC	Only for DO output;



DO output open	Password + DOO	The close time is 0-65535, unit second, default 0, indicating that the pulse output is always closed.
Query the current state	Password + DOE	
Pulse output close time	Password + DOT + 'close time'	
Query pulse close time	Password + DOT	
Control pulse output	Password + DOP	
Set threshold high and low	Password + AINR + 'serial number' + L + 'threshold low' + H + 'threshold high' + #	Only for AIN, DS18B20, AM2301 input;
Inquiry threshold high and low	Password + AINR	The serial number is 1 or 2 (1 represents AIN or temperature, 2 represents humidity); The threshold low and threshold high of AIN and temperature should be set at 10 times the actual value.
Set the range of AIN	Password + AINM + L + 'minimum' + H + 'maximum' + #	Only for AIN input; The minimum and maximum should be set at 10 times the actual value.
Inquiry the range of AIN	Password + AINM	
Calibrate the accuracy of AIN	Password + VOL='calibration value'	Only for AIN input; The calibration value is generally 3200~3400; The factory accuracy is calibrated and please do not set it if no necessary.
Inquiry the calibration value of AIN	Password + VOL	
Delete cache data	Password + HISDEL	
Reboot Device	Password + REBOOT	
Restore factory settings	Password + RESET	
Set to Chinese	Password + CH	
Set to English	Password + EN	
Clear DIN Pulse counting	Password + PDEL	Just for DIN

If you have any questions, please contact us.

<http://WWW.IOT-SOLUTION.COM>

---End---